

STANDARD 220 SQUARE STACKABLE "STANDARD PACKAGE OF OPTIONAL EQUIPMENT"

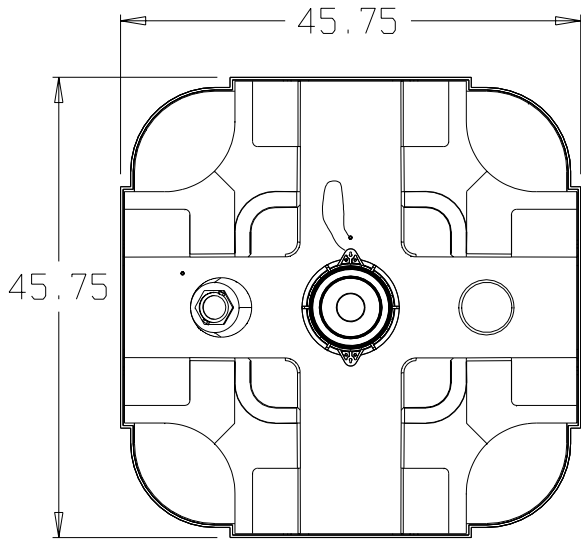

ITEM #	DESCRIPTION	QTY.	PART NUMBER
1	TANK - 1 (ANGLED) BUNG TANK WITH 6.5" CAP AND BOTTOM DRAIN HDPE NATURAL. (WITH CAP LANYARD INSERT AND WITH TAMPER EVIDENCE INSERTS MOLDED IN)	1	66308
2	BASE - H.W. 4 WAY PALLETJACKABLE HDPE BLACK.	1	65549
3	S.I.I. PROPRIETARY 2" NPS REPLACEABLE BUNG GLASS FILLED POLYETHYLENE W/VITON O-RING SEAL	1	N/A
4	2" NPS RIEKE POLYETHYLENE BUNG PLUGS WITH EPDM FLAT GASKETS	1	347340
5	6.5" GEM CAP WITH 2" NPS CENTER OPENING AND EPDM CAP GASKET. EQUIPPED WITH LID TIE	1	347795
6	S.I.I. 2" NPS VACUUM RELIEF VENT WITH EPDM DISK AND FLAT GASKET (AVERAGE GRAVITY FLOW RATE OF 70 GALLONS PER MINUTE)	1	347854
7	2" BANJO STANDARD PORT GLASS FILLED POLYPROPYLENE BOTTOM DRAIN VALVE WITH TEFLON SEATS AND BALL AND 18/8 S.S. BOLTS. INCLUDES DUST CAP AND CAP LANYARD.	1	347718

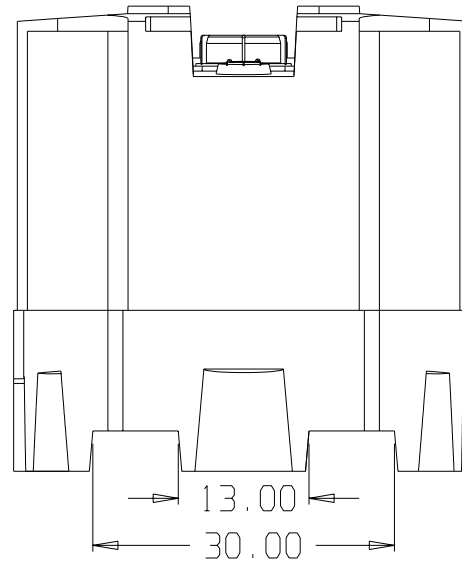
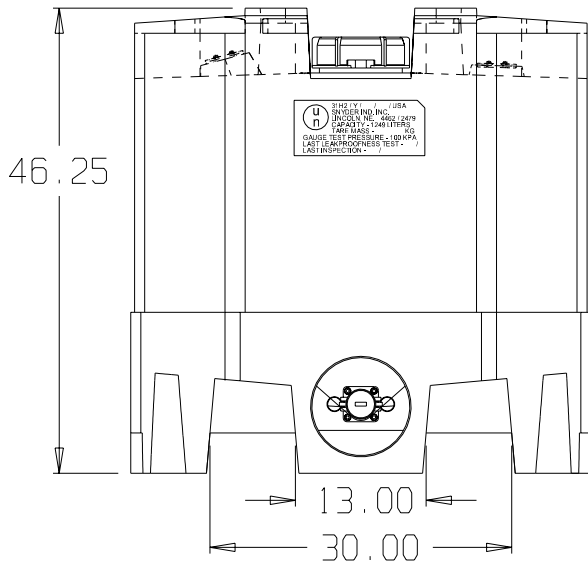

U.N. MARKING ON TANK READS:

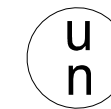

31H2 / Y / MO. / YR. / USA
 SNYDER IND. INC.
 LINCOLN, NE. 4462 / 1668
 CAPACITY - 833 LITERS
 TARE MASS - ACTUAL KG
 GAUGE TEST PRESSURE - 100 KPA
 LAST LEAKPROOFNESS TEST - MO. / YR.
 LAST INSPECTION - MO. / YR.

(all dimensions in inches)

IBC TANK PART# 66308

STANDARD 220 GALLON SQUARE-STACKABLE IBC

REF#: 0000

08/05/02

SNYDER INDUSTRIES INC.